

# FPN 10-8000-1H Centrifugal fire pump

Art. 022172

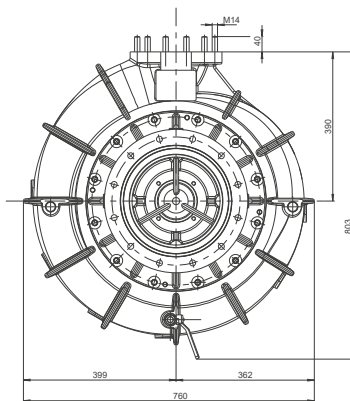

<b>Norms/Standards</b>	DIN EN 1028; CCCF
<b>RPM max.</b>	2,500 min <sup>-1</sup>
<b>Power input max.</b>	270 kW (368 HP)
<b>Pump output max.</b>	10,500 l/min at 10 bar and H <sub>s</sub> 3.0 m
<b>Torque max.</b>	1,000 Nm
<b>Weight</b>	approx. 210 kg
<b>Dimensions</b>	L x W x H: 730 x 760 x 770 mm
<b>Gear ratio</b>	1:0.93   1:1.07   1:1.23   1:1.48
<b>Priming system</b>	Trokomat

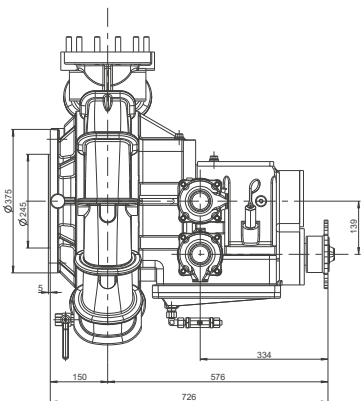
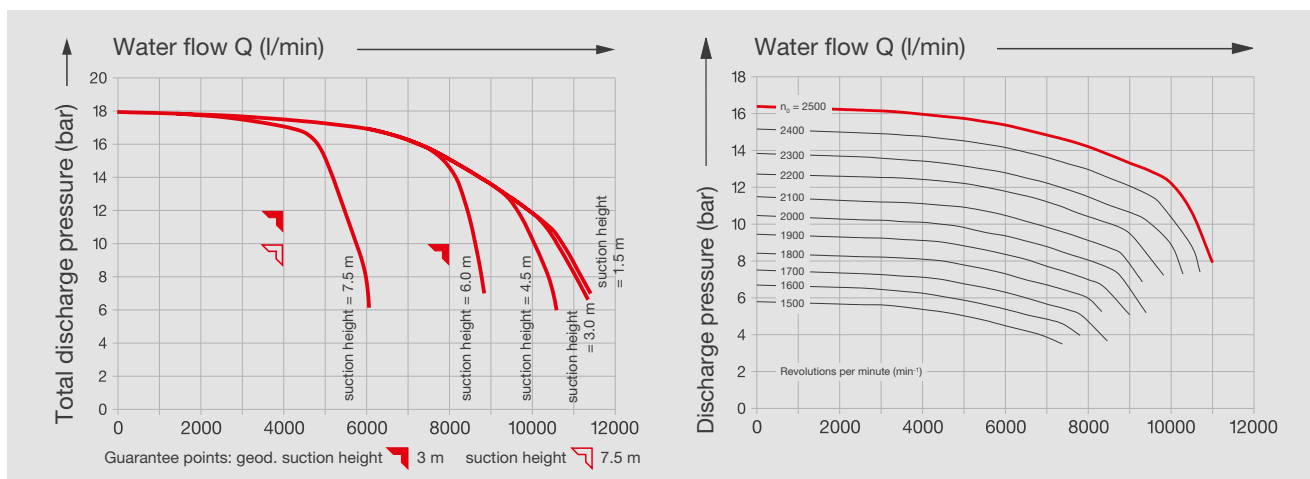

Illustrations may contain accessories and/or special equipment that are not part of the standard scope of delivery or service. Technical changes reserved. We cannot accept any liability for printing errors.



**Albert Ziegler GmbH**  
 Albert-Ziegler-Strasse 1  
 89537 Giengen/Brenz  
 Germany

Phone +49 (0)7322 951-0  
 Fax +49 (0)7322 951-211  
 info@ziegler.de



**We provide security.**  
 www.ziegler.de

D3205-1-0721