

TECHNICAL SPECIFICATIONS G6s CUTTER

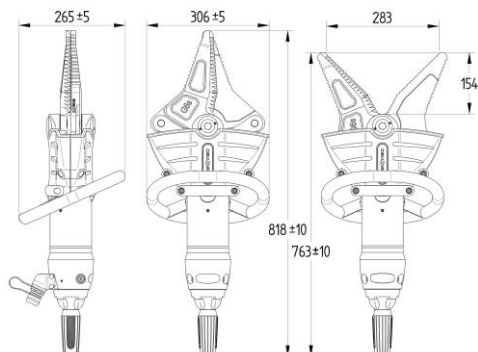

G6s CUTTER

NEO1 

HP/FF 

Nominal pressure	Optimized 350 bar	Optimized 350 bar
Tailhose safety factor	-	8:1 (2,800 bar)
Dimensions (L x W x H)	818 x 306 x 265 mm	818 x 306 x 265 mm
Operational weight	17.9 kg	17.7 kg
Max. cutting opening	283 mm	283 mm
Reach	154 mm	154 mm
Max. cutting force	1,251 kN / 127.5 ton	1,251 kN / 127.5 ton
EN 13204	CC 205H-18	CC 205H-18
NFPA 1936	A8 B8 C7 D8 E8	A8 B8 C7 D8 E8

ACCESSORIES

Art Nr.

LED light add-on

9500.1000



Information contained in this document is believed to be accurate. However RESQTEC does not guarantee the completeness or accuracy of any of the published information.

RESQTEC Zumro B.V.

Meer en Duin 82 | 2163 HC Lisse, the Netherlands

T +31 (0)252 419002

E info@resqtec.com

F +31 (0)252 411794

W www.resqtec.com

RESQTEC[®]





CUTTING PERFORMANCE AS PER EN13204 TABLE 3 FOR CUTTERS AND COMBI TOOLS

DU004K00

Manufacturer	RESQTEC
Tool name and type	G6S CUTTER





CLAIMED CLASSIFICATION;

TYPE	CUTTER OPENING	CLASSIFICATION BASED ON MIN CUTTING PERFORMANCE	WEIGHT (1 decimal accurate)	CUTTING PERFORMANCE
CC	205	H	17.7	1H-2H-3H-4H-5H

PROFILE TYPE →	1 Round bar	2 Flat bar	3 Round tube	4 Square tube	5 Rectangular tube
CATEGORY LETTER ↓					
A	≥ 14	30 x 5	21,3 x 2,3		
B	≥ 16	40 x 5	26,4 x 2,3		
C	≥ 18	50 x 5	33,7 x 2,6	35 x 3	
D	≥ 20	60 x 5	42,6 x 2,6	40 x 4	50 x 25 x 2,5
E	≥ 22	80 x 8	48,3 x 2,9	45 x 4	50 x 30 x 3,0
F	≥ 24	80 x 10	60,3 x 2,9	50 x 4	60 x 40 x 3,0
G	≥ 26	100 x 10	76,1 x 3,2	55 x 4	80 x 40 x 3,0
H	≥ 28	110 x 10	76,1 x 4,0	60 x 4	80 x 40 x 4,0
I	≥ 32	120 x 10	88,9 x 4,0	60 x 5	80 x 40 x 5,0
J	≥ 36	130 x 10	88,9 x 5,0	70 x 4	100 x 50 x 4,0
K	≥ 40	140 x 10	101,6 x 4,0	70 x 5	100 x 50 x 5,0

CUTTING PERFORMANCE AS PER NFPA 1936 FOR CUTTERS AND COMBI TOOLS

A8 B8 C7 D8 E8

PROFILE TYPE →	A Round bar		B Flat bar		C Round pipe		D Square tube		E Angle iron		
PERFORMANCE LEVEL ↓											
	inch	mm	inch	mm	inch	mm	inch	mm	inch	mm	
1	3/8	9.5	1/4 x 1/2	6.4 x 13.7	3/8	0.68 x 0.09	17.2 x 2.2	1/2 x 0.06	12.7 x 1.5	1/2 x 1/8	12.7 x 3.17
2	1/2	12.7	1/4 x 1	6.4 x 25.4	3/4	1.05 x 0.11	26.6 x 2.79	1 3/4 x 0.06	19.1 x 1.5	1 x 1/8	25.4 x 3.17
3	5/8	15.8	1/4 x 2	6.4 x 50.8	1	1.32 x 0.13	33.5 x 3.3	1 x 0.08	25.4 x 2	1 1/4 x 3/16	31.7 x 4.8
4	3/4	19.1	1/4 x 3	6.4 x 76.2	1 1/4	1.66 x 0.14	42.2 x 3.2	1 1/4 x 0.12	31.7 x 3	1 1/2 x 3/16	38.1 x 4.8
5	7/8	22.2	1/4 x 4	6.4 x 101.6	1 1/2	1.90 x 0.15	48.3 x 3.2	1 1/2 x 0.12	38.1 x 3	1 1/2 x 1/4	38.1 x 6.35
6	1	25.4	3/8 x 3	9.5 x 76.2	2	2.38 x 0.15	60.5 x 3.8	1 3/4 x 0.12	44.5 x 3	1 3/4 x 1/4	44.5 x 6.35
7	1 1/4	31.8	3/8 x 4	9.5 x 101.6	2 1/2	2.88 x 0.20	73.2 x 5.1	2 x 0.15	50.8 x 3.8	1 1/2 x 3/8	38.1 x 9.5
8	1 1/2	38.1	3/8 x 5	9.5 x 126	3	3.50 x 0.22	88.9 x 5.6	2 1/2 x 0.19	63.5 x 4.6	2 x 3/8	50.8 x 9.5
9	1 3/4	44.45	3/8 x 6	9.5 x 152.4	3 1/2	4.00 x 0.23	101.6 x 5.8	3 x 0.19	76.2 x 4.8	2 1/2 x 3/8	63.5 x 9.5